

Data sheet | Item number: 2022-1201

1-conductor/1-pin carrier terminal block; for DIN-rail 35 x 15 and 35 x 7.5;
2.5 mm²; Push-in CAGE CLAMP®

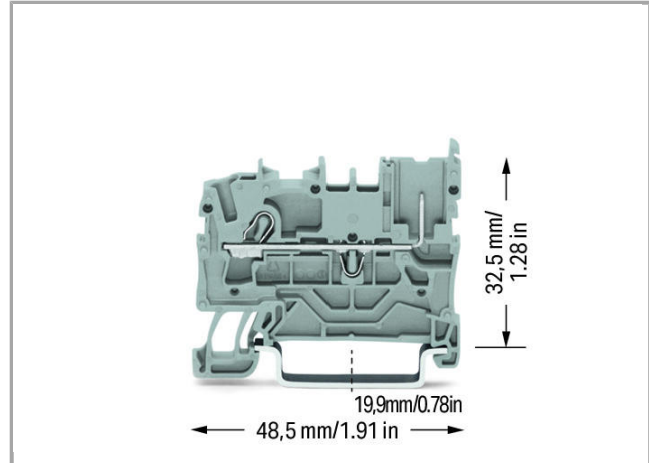

2022-1201



RoHS Compliant

[BOMcheck.net](https://www.bomcheck.net)

Color: ■

Data

Electrical data

Ratings per IEC/EN 60664-1

Rated voltage (III / 3)	690 V
Rated impulse voltage (III / 3)	6 kV
Rated current	24 A
Rated current (2)	32 A

Connection data

Connection technology	Push-in CAGE CLAMP®
Actuation type	Open Tool Slot Push-in
Connectable conductor materials	Copper
Nominal cross section	2.5 mm ²

Solid conductor	0.25 ... 4 mm ² / 22 ... 12 AWG
Solid conductor, push-in termination	0.75 ... 4 mm ² / 18 ... 12 AWG
Fine-stranded conductor	0.25 ... 4 mm ² / 22 ... 12 AWG
Strip length	10 ... 12 mm / 0.39 ... 0.47 inch
Note (conductor cross-section)	Depending on the conductor characteristic, a conductor with a smaller cross section can also be inserted via push-in termination.
Total number of connection points	1
Total number of potentials	1
Number of levels	1
Type of wiring	Front-entry wiring

Geometrical Data

Width	5.2 mm / 0.205 inch
Height from upper-edge of DIN-35 rail	32.5 mm / 1.28 inch
Depth	48.5 mm / 1.909 inch

Mechanical data

Design	horizontal
Type of mounting	DIN-35 rail
Marking level	Center/side marking

Material Data

Color	gray
Insulating material	Polyamide 66 (PA 66)
Fire load	0.112 MJ
Weight	5.038 g

Commercial data

Product Group	18 (X-COM-System)
Country of origin	CN
GTIN	4050821145059
Customs Tariff No.	85366990990

Approvals / Certificates

Country specific Approvals

Logo	Approval	Additional Approval Text	Certificate name
	CCA DEKRA Certification B.V.	EN 60947	NTR NL 7628



CSA
 DEKRA Certification B.V.

C22.2 No. 158

70107915

UL-Approvals

Logo	Approval	Additional Approval Text	Certificate name
	UR Underwriters Laboratories Inc.	UL 1059	E45172

Compatible products

End plate

	Item no.: 2022-1291 End and intermediate plate; 1 mm thick	2022-1291
	Item no.: 2022-1292 End and intermediate plate; 1 mm thick	2022-1292



Protective Warning Marker



















	Item no.: 2002-115 Protective warning marker; with high-voltage symbol, black; for 5 terminal blocks	2002-115
--	---	----------

















Coding







	Item no.: 2022-100 Carrier with 6 coding pins; for coding of female plugs	2022-100
--	--	----------









Carrier rail













	Item no.: 210-112 Steel carrier rail; 35 x 7.5 mm; 1 mm thick; 2 m long; slotted; according to EN 60715; "Hole width 25 mm	210-112
	Item no.: 210-113 Steel carrier rail; 35 x 7.5 mm; 1 mm thick; 2 m long; unslotted; according to EN 60715	210-113
	Item no.: 210-114 Steel carrier rail; 35 x 15 mm; 1.5 mm thick; 2 m long; unslotted; similar to EN 60715	210-114
	Item no.: 210-115	















	Steel carrier rail; 35 x 7.5 mm; 1 mm thick; 2 m long; slotted; according to EN 60715; "Hole width 18 mm	210-115
	Item no.: 210-118 Steel carrier rail; 35 x 15 mm; 2.3 mm thick; 2 m long; unslotted; according to EN 60715	210-118
	Item no.: 210-196 Aluminum carrier rail; 35 x 8.2 mm; 1.6 mm thick; 2 m long; unslotted; similar to EN 60715	210-196
	Item no.: 210-197 Steel carrier rail; 35 x 15 mm; 1.5 mm thick; 2 m long; slotted; similar to EN 60715	210-197
	Item no.: 210-198 Copper carrier rail; 35 x 15 mm; 2.3 mm thick; 2 m long; unslotted; according to EN 60715	210-198
Insulation stop		
	Item no.: 2002-171 Insulation stop; 0.25 - 0.5 mm ² ; 5 pieces/strip	2002-171
	Item no.: 2002-172 Insulation stop; 0.75 - 1 mm ² ; 5 pieces/strip	2002-172
tools		
	Item no.: 210-720 Operating tool with partially insulated shaft; Type 2, blade (3.5 x 0.5) mm	210-720
check		
	Item no.: 2002-511 Modular TOPJOB®S connector; modular; for jumper contact slot; 1-pole	2002-511
	Item no.: 2002-549 Spacer module; modular; e.g., for bridging commoned terminal blocks	2002-549
	Item no.: 2002-552 Modular TOPJOB®S connector; modular; for jumper contact slot; 2-pole	2002-552
	Item no.: 2002-553 Modular TOPJOB®S connector; modular; for jumper contact slot; 3-pole	2002-553
	Item no.: 2002-554 Modular TOPJOB®S connector; modular; for jumper contact slot; 4-pole	2002-554
	Item no.: 2002-555 Modular TOPJOB®S connector; modular; for jumper contact slot; 5-pole	2002-555
	Item no.: 2002-556 Modular TOPJOB®S connector; modular; for jumper contact slot; 6-pole	2002-556
	Item no.: 2002-557 Modular TOPJOB®S connector; modular; for jumper contact slot; 7-pole	2002-557
	Item no.: 2002-558 Modular TOPJOB®S connector; modular; for jumper contact slot; 8-pole	2002-558
	Item no.: 2002-559 Modular TOPJOB®S connector; modular; for jumper contact slot; 9-pole	2002-559
	Item no.: 2002-560 Modular TOPJOB®S connector; modular; for jumper contact slot; 10-pole	2002-560









	Item no.: 2009-174 Test plug adapter; for 4 mm Ø test plugs; for testing TOPJOB®S rail-mounted terminal blocks	2009-174
	Item no.: 2009-182 Testing tap; for max. 2.5 mm ² ; tool-free connection for individual test wires 0.08 - 2.5 mm	2009-182
	Item no.: 859-500 Test pin; 1 mm Ø; with solder connection for test wire	859-500
ferrule		
	Item no.: 216-241 Ferrule; Sleeve for 0.5 mm ² / 20 AWG; insulated; electro-tin plated; electrolytic copper; gastight crimped; acc. to DIN 46228, Part 4/09.90	216-241
	Item no.: 216-242 Ferrule; Sleeve for 0.75 mm ² / 18 AWG; insulated; electro-tin plated; electrolytic copper; gastight crimped; acc. to DIN 46228, Part 4/09.90	216-242
	Item no.: 216-243 Ferrule; Sleeve for 1 mm ² / AWG 18; insulated; electro-tin plated; electrolytic copper; gastight crimped; acc. to DIN 46228, Part 4/09.90	216-243
	Item no.: 216-244 Ferrule; Sleeve for 1.5 mm ² / AWG 16; insulated; electro-tin plated; electrolytic copper; gastight crimped; acc. to DIN 46228, Part 4/09.90	216-244
	Item no.: 216-246 Ferrule; Sleeve for 2.5 mm ² / AWG 14; insulated; electro-tin plated; electrolytic copper; gastight crimped; acc. to DIN 46228, Part 4/09.90	216-246
	Item no.: 216-262 Ferrule; Sleeve for 0.75 mm ² / 18 AWG; insulated; electro-tin plated; electrolytic copper; gastight crimped; acc. to DIN 46228, Part 4/09.90	216-262
	Item no.: 216-263 Ferrule; Sleeve for 1 mm ² / AWG 18; insulated; electro-tin plated; electrolytic copper; gastight crimped; acc. to DIN 46228, Part 4/09.90	216-263
	Item no.: 216-264 Ferrule; Sleeve for 1.5 mm ² / AWG 16; insulated; electro-tin plated; electrolytic copper; gastight crimped; acc. to DIN 46228, Part 4/09.90	216-264
	Item no.: 216-266 Ferrule; Sleeve for 2.5 mm ² / AWG 14; insulated; electro-tin plated; electrolytic copper; gastight crimped; acc. to DIN 46228, Part 4/09.90	216-266
	Item no.: 216-284 Ferrule; Sleeve for 1.5 mm ² / AWG 16; insulated; electro-tin plated; electrolytic copper; gastight crimped; acc. to DIN 46228, Part 4/09.90	216-284
	Item no.: 216-286 Ferrule; Sleeve for 2.5 mm ² / AWG 14; insulated; electro-tin plated; electrolytic copper; gastight crimped; acc. to DIN 46228, Part 4/09.90	216-286
Female plug		
	Item no.: 2022-101 1-conductor female plug; 2.5 mm ² ; 1-pole	2022-101
	Item no.: 2022-101/000-006 1-conductor female plug; 1-pole	2022-101 /000-006
	Item no.: 2022-101/000-012 1-conductor female plug; 1-pole	2022-101 /000-012













	Item no.: 2022-101/000-016 1-conductor female plug; 1-pole	/000-016	2022-101
	Item no.: 2022-101/122-000 1-conductor female plug; 1-pole	/122-000	2022-101
	Item no.: 2022-101/122-006 1-conductor female plug; 1-pole	/122-006	2022-101
	Item no.: 2022-101/122-016 1-conductor female plug; 1-pole	/122-016	2022-101
	Item no.: 2022-101/132-000 1-conductor female plug; Strain relief plate; 1-pole	/132-000	2022-101
	Item no.: 2022-101/132-006 1-conductor female plug; Strain relief plate; 1-pole	/132-006	2022-101
	Item no.: 2022-101/132-016 1-conductor female plug; Strain relief plate; 1-pole	/132-016	2022-101
	Item no.: 2022-101/142-000 1-conductor female plug; Strain relief plate; 1-pole	/142-000	2022-101
	Item no.: 2022-101/142-006 1-conductor female plug; Strain relief plate; 1-pole	/142-006	2022-101
	Item no.: 2022-101/142-016 1-conductor female plug; Strain relief plate; 1-pole	/142-016	2022-101
	Item no.: 2022-102 1-conductor female plug; 2.5 mm ² ; 2-pole		2022-102
	Item no.: 2022-102/000-006 1-conductor female plug; 2.5 mm ² ; 2-pole	/000-006	2022-102
	Item no.: 2022-102/000-012 1-conductor female plug; 2.5 mm ² ; 2-pole	/000-012	2022-102
	Item no.: 2022-102/000-016 1-conductor female plug; 2.5 mm ² ; 2-pole	/000-016	2022-102
	Item no.: 2022-102/000-038 1-conductor female plug; 2.5 mm ² ; 2-pole	/000-038	2022-102











	Item no.: 2022-102/000-039 1-conductor female plug; 2.5 mm ² ; 2-pole	/000-039	2022-102
	Item no.: 2022-102/122-000 1-conductor female plug; Locking lever; 2.5 mm ² ; 2-pole	/122-000	2022-102
	Item no.: 2022-102/132-000 1-conductor female plug; Strain relief plate; 2.5 mm ² ; 2-pole	/132-000	2022-102
	Item no.: 2022-102/142-000 1-conductor female plug; Strain relief plate; 2.5 mm ² ; 2-pole	/142-000	2022-102
	Item no.: 2022-103 1-conductor female plug; 2.5 mm ² ; 3-pole		2022-103
	Item no.: 2022-103/000-006 1-conductor female plug; 2.5 mm ² ; 3-pole	/000-006	2022-103
	Item no.: 2022-103/000-012 1-conductor female plug; 2.5 mm ² ; 3-pole	/000-012	2022-103
	Item no.: 2022-103/000-016 1-conductor female plug; 2.5 mm ² ; 3-pole	/000-016	2022-103
	Item no.: 2022-103/000-036 1-conductor female plug; 2.5 mm ² ; 3-pole	/000-036	2022-103
	Item no.: 2022-103/000-037 1-conductor female plug; 2.5 mm ² ; 3-pole	/000-037	2022-103
	Item no.: 2022-103/000-038 1-conductor female plug; 2.5 mm ² ; 3-pole	/000-038	2022-103
	Item no.: 2022-103/000-039 1-conductor female plug; 2.5 mm ² ; 3-pole	/000-039	2022-103
	Item no.: 2022-103/123-000 1-conductor female plug; Locking lever; 2.5 mm ² ; 3-pole	/123-000	2022-103
	Item no.: 2022-103/133-000 1-conductor female plug; Strain relief plate; 2.5 mm ² ; 3-pole	/133-000	2022-103
	Item no.: 2022-103/143-000 1-conductor female plug; Strain relief plate; 2.5 mm ² ; 3-pole	/143-000	2022-103











	Item no.: 2022-104 1-conductor female plug; 2.5 mm ² ; 4-pole		2022-104
	Item no.: 2022-104/000-006 1-conductor female plug; 2.5 mm ² ; 4-pole	/000-006	2022-104
	Item no.: 2022-104/000-012 1-conductor female plug; 2.5 mm ² ; 4-pole	/000-012	2022-104
	Item no.: 2022-104/000-016 1-conductor female plug; 2.5 mm ² ; 4-pole	/000-016	2022-104
	Item no.: 2022-104/000-036 1-conductor female plug; 2.5 mm ² ; 4-pole	/000-036	2022-104
	Item no.: 2022-104/000-037 1-conductor female plug; 2.5 mm ² ; 4-pole	/000-037	2022-104
	Item no.: 2022-104/000-038 1-conductor female plug; 2.5 mm ² ; 4-pole	/000-038	2022-104
	Item no.: 2022-104/000-039 1-conductor female plug; 2.5 mm ² ; 4-pole	/000-039	2022-104
	Item no.: 2022-104/123-000 1-conductor female plug; Locking lever; 2.5 mm ² ; 4-pole	/123-000	2022-104
	Item no.: 2022-104/133-000 1-conductor female plug; Strain relief plate; 2.5 mm ² ; 4-pole	/133-000	2022-104
	Item no.: 2022-104/143-000 1-conductor female plug; Strain relief plate; 2.5 mm ² ; 4-pole	/143-000	2022-104
	Item no.: 2022-105 1-conductor female plug; 2.5 mm ² ; 5-pole		2022-105
	Item no.: 2022-105/000-006 1-conductor female plug; 2.5 mm ² ; 5-pole	/000-006	2022-105
	Item no.: 2022-105/000-012 1-conductor female plug; 2.5 mm ² ; 5-pole	/000-012	2022-105
	Item no.: 2022-105/000-016 1-conductor female plug; 2.5 mm ² ; 5-pole	/000-016	2022-105













	Item no.: 2022-105/000-036 1-conductor female plug; 2.5 mm ² ; 5-pole	/000-036	2022-105
	Item no.: 2022-105/000-037 1-conductor female plug; 2.5 mm ² ; 5-pole	/000-037	2022-105
	Item no.: 2022-105/000-038 1-conductor female plug; 2.5 mm ² ; 5-pole	/000-038	2022-105
	Item no.: 2022-105/000-039 1-conductor female plug; 2.5 mm ² ; 5-pole	/000-039	2022-105
	Item no.: 2022-105/123-000 1-conductor female plug; Locking lever; 2.5 mm ² ; 5-pole	/123-000	2022-105
	Item no.: 2022-105/134-000 1-conductor female plug; Strain relief plate; 2.5 mm ² ; 5-pole	/134-000	2022-105
	Item no.: 2022-105/144-000 1-conductor female plug; Strain relief plate; 2.5 mm ² ; 5-pole	/144-000	2022-105
	Item no.: 2022-106 1-conductor female plug; 2.5 mm ² ; 6-pole		2022-106
	Item no.: 2022-106/000-006 1-conductor female plug; 2.5 mm ² ; 6-pole	/000-006	2022-106
	Item no.: 2022-106/000-012 1-conductor female plug; 2.5 mm ² ; 6-pole	/000-012	2022-106
	Item no.: 2022-106/000-016 1-conductor female plug; 2.5 mm ² ; 6-pole	/000-016	2022-106
	Item no.: 2022-106/000-036 1-conductor female plug; 2.5 mm ² ; 6-pole	/000-036	2022-106
	Item no.: 2022-106/000-037 1-conductor female plug; 2.5 mm ² ; 6-pole	/000-037	2022-106
	Item no.: 2022-106/000-038 1-conductor female plug; 2.5 mm ² ; 6-pole	/000-038	2022-106
	Item no.: 2022-106/000-039 1-conductor female plug; 2.5 mm ² ; 6-pole	/000-039	2022-106











	Item no.: 2022-106/123-000 1-conductor female plug; Locking lever; 2.5 mm ² ; 6-pole	/ 123-000	2022-106
	Item no.: 2022-106/134-000 1-conductor female plug; Strain relief plate; 2.5 mm ² ; 6-pole	/ 134-000	2022-106
	Item no.: 2022-106/144-000 1-conductor female plug; Strain relief plate; 2.5 mm ² ; 6-pole	/ 144-000	2022-106
	Item no.: 2022-107 1-conductor female plug; 2.5 mm ² ; 7-pole		2022-107
	Item no.: 2022-107/000-006 1-conductor female plug; 2.5 mm ² ; 7-pole	/000-006	2022-107
	Item no.: 2022-107/000-012 1-conductor female plug; 2.5 mm ² ; 7-pole	/000-012	2022-107
	Item no.: 2022-107/000-016 1-conductor female plug; 2.5 mm ² ; 7-pole	/000-016	2022-107
	Item no.: 2022-107/000-036 1-conductor female plug; 2.5 mm ² ; 7-pole	/000-036	2022-107
	Item no.: 2022-107/000-037 1-conductor female plug; 2.5 mm ² ; 7-pole	/000-037	2022-107
	Item no.: 2022-107/000-038 1-conductor female plug; 2.5 mm ² ; 7-pole	/000-038	2022-107
	Item no.: 2022-107/000-039 1-conductor female plug; 2.5 mm ² ; 7-pole	/000-039	2022-107
	Item no.: 2022-107/123-000 1-conductor female plug; Locking lever; 2.5 mm ² ; 7-pole	/ 123-000	2022-107
	Item no.: 2022-107/135-000 1-conductor female plug; Strain relief plate; 2.5 mm ² ; 7-pole	/ 135-000	2022-107
	Item no.: 2022-107/145-000 1-conductor female plug; Strain relief plate; 2.5 mm ² ; 7-pole	/ 145-000	2022-107
	Item no.: 2022-108 1-conductor female plug; 2.5 mm ² ; 8-pole		2022-108











	Item no.: 2022-108/000-006 1-conductor female plug; 2.5 mm ² ; 8-pole	/000-006	2022-108
	Item no.: 2022-108/000-012 1-conductor female plug; 2.5 mm ² ; 8-pole	/000-012	2022-108
	Item no.: 2022-108/000-016 1-conductor female plug; 2.5 mm ² ; 8-pole	/000-016	2022-108
	Item no.: 2022-108/000-036 1-conductor female plug; 2.5 mm ² ; 8-pole	/000-036	2022-108
	Item no.: 2022-108/000-037 1-conductor female plug; 2.5 mm ² ; 8-pole	/000-037	2022-108
	Item no.: 2022-108/000-038 1-conductor female plug; 2.5 mm ² ; 8-pole	/000-038	2022-108
	Item no.: 2022-108/000-039 1-conductor female plug; 2.5 mm ² ; 8-pole	/000-039	2022-108
	Item no.: 2022-108/123-000 1-conductor female plug; Locking lever; 2.5 mm ² ; 8-pole	/123-000	2022-108
	Item no.: 2022-108/135-000 1-conductor female plug; Strain relief plate; 2.5 mm ² ; 8-pole	/135-000	2022-108
	Item no.: 2022-108/145-000 1-conductor female plug; Strain relief plate; 2.5 mm ² ; 8-pole	/145-000	2022-108
	Item no.: 2022-109 1-conductor female plug; 2.5 mm ² ; 9-pole		2022-109
	Item no.: 2022-109/000-006 1-conductor female plug; 2.5 mm ² ; 9-pole	/000-006	2022-109
	Item no.: 2022-109/000-012 1-conductor female plug; 2.5 mm ² ; 9-pole	/000-012	2022-109
	Item no.: 2022-109/000-016 1-conductor female plug; 2.5 mm ² ; 9-pole	/000-016	2022-109
	Item no.: 2022-109/000-036 1-conductor female plug; 2.5 mm ² ; 9-pole	/000-036	2022-109

















	Item no.: 2022-109/000-037 1-conductor female plug; 2.5 mm ² ; 9-pole	/000-037	2022-109
	Item no.: 2022-109/000-038 1-conductor female plug; 2.5 mm ² ; 9-pole	/000-038	2022-109
	Item no.: 2022-109/000-039 1-conductor female plug; 2.5 mm ² ; 9-pole	/000-039	2022-109
	Item no.: 2022-109/123-000 1-conductor female plug; Locking lever; 2.5 mm ² ; 9-pole	/123-000	2022-109
	Item no.: 2022-109/135-000 1-conductor female plug; Strain relief plate; 2.5 mm ² ; 9-pole	/135-000	2022-109
	Item no.: 2022-109/145-000 1-conductor female plug; Strain relief plate; 2.5 mm ² ; 9-pole	/145-000	2022-109
	Item no.: 2022-110 1-conductor female plug; 2.5 mm ² ; 10-pole		2022-110
	Item no.: 2022-110/000-006 1-conductor female plug; 2.5 mm ² ; 10-pole	/000-006	2022-110
	Item no.: 2022-110/000-012 1-conductor female plug; 2.5 mm ² ; 10-pole	/000-012	2022-110
	Item no.: 2022-110/000-016 1-conductor female plug; 2.5 mm ² ; 10-pole	/000-016	2022-110
	Item no.: 2022-110/000-036 1-conductor female plug; 2.5 mm ² ; 10-pole	/000-036	2022-110
	Item no.: 2022-110/000-037 1-conductor female plug; 2.5 mm ² ; 10-pole	/000-037	2022-110
	Item no.: 2022-110/000-038 1-conductor female plug; 2.5 mm ² ; 10-pole	/000-038	2022-110
	Item no.: 2022-110/000-039 1-conductor female plug; 2.5 mm ² ; 10-pole	/000-039	2022-110
	Item no.: 2022-110/123-000 1-conductor female plug; Locking lever; 2.5 mm ² ; 10-pole	/123-000	2022-110

















	Item no.: 2022-110/135-000 1-conductor female plug; Strain relief plate; 2.5 mm ² ; 10-pole	/ 135-000	2022-110
	Item no.: 2022-110/145-000 1-conductor female plug; Strain relief plate; 2.5 mm ² ; 10-pole	/ 145-000	2022-110
	Item no.: 2022-111 1-conductor female plug; 2.5 mm ² ; 11-pole		2022-111
	Item no.: 2022-111/000-006 1-conductor female plug; 2.5 mm ² ; 11-pole	/000-006	2022-111
	Item no.: 2022-111/000-012 1-conductor female plug; 2.5 mm ² ; 11-pole	/000-012	2022-111
	Item no.: 2022-111/000-016 1-conductor female plug; 2.5 mm ² ; 11-pole	/000-016	2022-111
	Item no.: 2022-111/000-036 1-conductor female plug; 2.5 mm ² ; 11-pole	/000-036	2022-111
	Item no.: 2022-111/000-037 1-conductor female plug; 2.5 mm ² ; 11-pole	/000-037	2022-111
	Item no.: 2022-111/000-038 1-conductor female plug; 2.5 mm ² ; 11-pole	/000-038	2022-111
	Item no.: 2022-111/000-039 1-conductor female plug; 2.5 mm ² ; 11-pole	/000-039	2022-111
	Item no.: 2022-111/126-000 1-conductor female plug; Locking lever; 2.5 mm ² ; 11-pole	/ 126-000	2022-111
	Item no.: 2022-111/136-000 1-conductor female plug; Strain relief plate; 2.5 mm ² ; 11-pole	/ 136-000	2022-111
	Item no.: 2022-111/146-000 1-conductor female plug; Strain relief plate; 2.5 mm ² ; 11-pole	/ 146-000	2022-111
	Item no.: 2022-112 1-conductor female plug; 2.5 mm ² ; 12-pole		2022-112
	Item no.: 2022-112/000-006 1-conductor female plug; 2.5 mm ² ; 12-pole	/000-006	2022-112















	Item no.: 2022-112/000-012 1-conductor female plug; 2.5 mm ² ; 12-pole	/000-012	2022-112
	Item no.: 2022-112/000-016 1-conductor female plug; 2.5 mm ² ; 12-pole	/000-016	2022-112
	Item no.: 2022-112/000-036 1-conductor female plug; 2.5 mm ² ; 12-pole	/000-036	2022-112
	Item no.: 2022-112/000-037 1-conductor female plug; 2.5 mm ² ; 12-pole	/000-037	2022-112
	Item no.: 2022-112/000-038 1-conductor female plug; 2.5 mm ² ; 12-pole	/000-038	2022-112
	Item no.: 2022-112/000-039 1-conductor female plug; 2.5 mm ² ; 12-pole	/000-039	2022-112
	Item no.: 2022-112/126-000 1-conductor female plug; Locking lever; 2.5 mm ² ; 12-pole	/126-000	2022-112
	Item no.: 2022-112/136-000 1-conductor female plug; Strain relief plate; 2.5 mm ² ; 12-pole	/136-000	2022-112
	Item no.: 2022-112/146-000 1-conductor female plug; Strain relief plate; 2.5 mm ² ; 12-pole	/146-000	2022-112
	Item no.: 2022-113 1-conductor female plug; 2.5 mm ² ; 13-pole		2022-113
	Item no.: 2022-113/000-006 1-conductor female plug; 2.5 mm ² ; 13-pole	/000-006	2022-113
	Item no.: 2022-113/000-012 1-conductor female plug; 2.5 mm ² ; 13-pole	/000-012	2022-113
	Item no.: 2022-113/000-016 1-conductor female plug; 2.5 mm ² ; 13-pole	/000-016	2022-113
	Item no.: 2022-113/000-036 1-conductor female plug; 2.5 mm ² ; 13-pole	/000-036	2022-113
	Item no.: 2022-113/000-037 1-conductor female plug; 2.5 mm ² ; 13-pole	/000-037	2022-113

	Item no.: 2022-113/000-038 1-conductor female plug; 2.5 mm ² ; 13-pole	/000-038	2022-113
	Item no.: 2022-113/000-039 1-conductor female plug; 2.5 mm ² ; 13-pole	/000-039	2022-113
	Item no.: 2022-113/126-000 1-conductor female plug; Locking lever; 2.5 mm ² ; 13-pole	/126-000	2022-113
	Item no.: 2022-113/136-000 1-conductor female plug; Strain relief plate; 2.5 mm ² ; 13-pole	/136-000	2022-113
	Item no.: 2022-113/146-000 1-conductor female plug; Strain relief plate; 2.5 mm ² ; 13-pole	/146-000	2022-113
	Item no.: 2022-114 1-conductor female plug; 2.5 mm ² ; 14-pole		2022-114
	Item no.: 2022-114/000-006 1-conductor female plug; 2.5 mm ² ; 14-pole	/000-006	2022-114
	Item no.: 2022-114/000-012 1-conductor female plug; 2.5 mm ² ; 14-pole	/000-012	2022-114
	Item no.: 2022-114/000-016 1-conductor female plug; 2.5 mm ² ; 14-pole	/000-016	2022-114
	Item no.: 2022-114/000-036 1-conductor female plug; 2.5 mm ² ; 14-pole	/000-036	2022-114
	Item no.: 2022-114/000-037 1-conductor female plug; 2.5 mm ² ; 14-pole	/000-037	2022-114
	Item no.: 2022-114/000-038 1-conductor female plug; 2.5 mm ² ; 14-pole	/000-038	2022-114
	Item no.: 2022-114/000-039 1-conductor female plug; 2.5 mm ² ; 14-pole	/000-039	2022-114
	Item no.: 2022-114/126-000 1-conductor female plug; Locking lever; 2.5 mm ² ; 14-pole	/126-000	2022-114
	Item no.: 2022-114/136-000 1-conductor female plug; Strain relief plate; 2.5 mm ² ; 14-pole	/136-000	2022-114

	Item no.: 2022-114/146-000 1-conductor female plug; Strain relief plate; 2.5 mm ² ; 14-pole	/ 146-000	2022-114
	Item no.: 2022-115 1-conductor female plug; 2.5 mm ² ; 15-pole		2022-115
	Item no.: 2022-115/000-006 1-conductor female plug; 2.5 mm ² ; 15-pole	/000-006	2022-115
	Item no.: 2022-115/000-012 1-conductor female plug; 2.5 mm ² ; 15-pole	/000-012	2022-115
	Item no.: 2022-115/000-016 1-conductor female plug; 2.5 mm ² ; 15-pole	/000-016	2022-115
	Item no.: 2022-115/000-036 1-conductor female plug; 2.5 mm ² ; 15-pole	/000-036	2022-115
	Item no.: 2022-115/000-037 1-conductor female plug; 2.5 mm ² ; 15-pole	/000-037	2022-115
	Item no.: 2022-115/000-038 1-conductor female plug; 2.5 mm ² ; 15-pole	/000-038	2022-115
	Item no.: 2022-115/000-039 1-conductor female plug; 2.5 mm ² ; 15-pole	/000-039	2022-115
	Item no.: 2022-115/127-000 1-conductor female plug; Locking lever; 2.5 mm ² ; 15-pole	/ 127-000	2022-115
	Item no.: 2022-115/137-000 1-conductor female plug; Strain relief plate; 2.5 mm ² ; 15-pole	/ 137-000	2022-115
	Item no.: 2022-115/147-000 1-conductor female plug; Strain relief plate; 2.5 mm ² ; 15-pole	/ 147-000	2022-115
Jumper			
	Item no.: 2002-400 Adjacent jumper for continuous commoning; insulated; 2-way; Nominal current 25 A		2002-400
	Item no.: 2002-402 Push-in type jumper bar; insulated; 2-way; Nominal current 25 A		2002-402
	Item no.: 2002-402/000-005 Push-in type jumper bar; insulated; 2-way; Nominal current 25 A	/000-005	2002-402

	Item no.: 2002-402/000-006 Push-in type jumper bar; insulated; 2-way; Nominal current 25 A	2002-402 /UUU-UU6
	Item no.: 2002-403 Push-in type jumper bar; insulated; 3-way; Nominal current 25 A	2002-403
	Item no.: 2002-403/000-005 Push-in type jumper bar; insulated; 3-way; Nominal current 25 A	2002-403 /UUU-UU5
	Item no.: 2002-403/000-006 Push-in type jumper bar; insulated; 3-way; Nominal current 25 A	2002-403 /UUU-UU6
	Item no.: 2002-404 Push-in type jumper bar; insulated; 4-way; Nominal current 25 A	2002-404
	Item no.: 2002-404/000-005 Push-in type jumper bar; insulated; 4-way; Nominal current 25 A	2002-404 /UUU-UU5
	Item no.: 2002-404/000-006 Push-in type jumper bar; insulated; 4-way; Nominal current 25 A	2002-404 /UUU-UU6
	Item no.: 2002-405 Push-in type jumper bar; insulated; 5-way; Nominal current 25 A	2002-405
	Item no.: 2002-405/000-005 Push-in type jumper bar; insulated; 5-way; Nominal current 25 A	2002-405 /UUU-UU5
	Item no.: 2002-405/000-006 Push-in type jumper bar; insulated; 5-way; Nominal current 25 A	2002-405 /UUU-UU6
	Item no.: 2002-405/011-000 Star point jumper; insulated; 3-way (1-3-5); IN = IN terminal block	2002-405 /U 1 1-UUU
	Item no.: 2002-406 Push-in type jumper bar; insulated; 6-way; Nominal current 25 A	2002-406
	Item no.: 2002-406/000-005 Push-in type jumper bar; insulated; 6-way; Nominal current 25 A	2002-406 /UUU-UU5
	Item no.: 2002-406/000-006 Push-in type jumper bar; insulated; 6-way; Nominal current 25 A	2002-406 /UUU-UU6
	Item no.: 2002-406/020-000 Delta jumper; insulated; 1-2 3-4 5-6; IN = IN terminal block	2002-406 /UZU-UUU
	Item no.: 2002-407 Push-in type jumper bar; insulated; 7-way; Nominal current 25 A	2002-407

	Item no.: 2022-407/000-005 Push-in type jumper bar; insulated; 7-way; Nominal current 25 A	2022-407
		/UUU-UU5
	Item no.: 2022-407/000-006 Push-in type jumper bar; insulated; 7-way; Nominal current 25 A	2022-407
		/UUU-UU6
	Item no.: 2022-408 Push-in type jumper bar; insulated; 8-way; Nominal current 25 A	2022-408
	Item no.: 2022-408/000-005 Push-in type jumper bar; insulated; 8-way; Nominal current 25 A	2022-408
		/UUU-UU5
	Item no.: 2022-408/000-006 Push-in type jumper bar; insulated; 8-way; Nominal current 25 A	2022-408
		/UUU-UU6
	Item no.: 2022-409 Push-in type jumper bar; insulated; 9-way; Nominal current 25 A	2022-409
	Item no.: 2022-409/000-005 Push-in type jumper bar; insulated; 9-way; Nominal current 25 A	2022-409
		/UUU-UU5
	Item no.: 2022-409/000-006 Push-in type jumper bar; insulated; 9-way; Nominal current 25 A	2022-409
		/UUU-UU6
	Item no.: 2022-410 Push-in type jumper bar; insulated; 10-way; Nominal current 25 A	2022-410
	Item no.: 2022-410/000-005 Push-in type jumper bar; insulated; 10-way; Nominal current 25 A	2022-410
		/UUU-UU5
	Item no.: 2022-410/000-006 Push-in type jumper bar; insulated; 10-way; Nominal current 25 A	2022-410
		/UUU-UU6
	Item no.: 2022-423 Adjacent jumper for continuous commoning; insulated; from 1 to 3; Nominal current 25 A	2022-423
	Item no.: 2022-423/000-005 Adjacent jumper for continuous commoning; insulated; from 1 to 3; Nominal current 25 A	2022-423
		/UUU-UU5
	Item no.: 2022-423/000-006 Adjacent jumper for continuous commoning; insulated; from 1 to 3; Nominal current 25 A	2022-423
		/UUU-UU6
	Item no.: 2022-433 Push-in type jumper bar; insulated; from 1 to 3; Nominal current 25 A	2022-433
	Item no.: 2022-434 Push-in type jumper bar; insulated; from 1 to 4; Nominal current 25 A	2022-434

	Item no.: 2022-435 Push-in type jumper bar; insulated; from 1 to 5; Nominal current 25 A	2022-435
	Item no.: 2022-436 Push-in type jumper bar; insulated; from 1 to 6; Nominal current 25 A	2022-436
	Item no.: 2022-437 Push-in type jumper bar; insulated; from 1 to 7; Nominal current 25 A	2022-437
	Item no.: 2022-438 Push-in type jumper bar; insulated; from 1 to 8; Nominal current 25 A	2022-438
	Item no.: 2022-439 Push-in type jumper bar; insulated; from 1 to 9; Nominal current 25 A	2022-439
	Item no.: 2022-440 Push-in type jumper bar; insulated; from 1 to 10; Nominal current 25 A	2022-440
	Item no.: 2022-472 Staggered jumper; insulated; 2-way; Nominal current 25 A; suitable for 2002 and 2003 Series rail-mounted terminal blocks	2022-472
	Item no.: 2022-473 Staggered jumper; insulated; 3-way; Nominal current 25 A; suitable for 2002 and 2003 Series rail-mounted terminal blocks	2022-473
	Item no.: 2022-473/011-000 Ready-made staggered jumper; insulated; 2-way (1-3); Nominal current 25 A; with contact lugs broken off at the factory and circuit marking	2022-473 /U 1 1-000
	Item no.: 2022-474 Staggered jumper; insulated; 4-way; Nominal current 25 A; suitable for 2002 and 2003 Series rail-mounted terminal blocks	2022-474
	Item no.: 2022-475 Staggered jumper; insulated; 5-way; Nominal current 25 A; suitable for 2002 and 2003 Series rail-mounted terminal blocks	2022-475
	Item no.: 2022-475/011-000 Ready-made staggered jumper; insulated; 3-way (1-3-5); Nominal current 25 A; with contact lugs broken off at the factory and circuit marking	2022-475 /U 1 1-000
	Item no.: 2022-476 Staggered jumper; insulated; 6-way; Nominal current 25 A; suitable for 2002 and 2003 Series rail-mounted terminal blocks	2022-476
	Item no.: 2022-477 Staggered jumper; insulated; 7-way; Nominal current 25 A; suitable for 2002 and 2003 Series rail-mounted terminal blocks	2022-477
	Item no.: 2022-477/011-000 Ready-made staggered jumper; insulated; 1-3-5-7; Nominal current 25 A; with contact lugs broken off at the factory and circuit marking	2022-477 /U 1 1-000
	Item no.: 2022-478 Staggered jumper; insulated; 8-way; Nominal current 25 A; suitable for 2002 and 2003 Series rail-mounted terminal blocks	2022-478
	Item no.: 2022-479 Staggered jumper; insulated; 9-way; Nominal current 25 A; suitable for 2002 and 2003 Series rail-mounted terminal blocks	2022-479
	Item no.: 2022-479/011-000	

Ready-made staggered jumper; insulated; 1-3-5-7-9; Nominal current 25 A; with contact lugs broken off at the factory and circuit marking

2022-479

/U11-000

**Item no.: 2002-480**

Staggered jumper; insulated; 10-way; Nominal current 25 A; suitable for 2002 and 2003 Series rail-mounted terminal blocks

2002-480

**Item no.: 2002-481**

Staggered jumper; insulated; 11-way; Nominal current 25 A; suitable for 2002 and 2003 Series rail-mounted terminal blocks

2002-481

Item no.: 2002-481/011-000

Ready-made staggered jumper; insulated; 1-3-5-7-9-11; Nominal current 25 A; with contact lugs broken off at the factory and circuit marking

2002-481

/U11-000

**Item no.: 2002-482**

Staggered jumper; insulated; 12-way; Nominal current 25 A; suitable for 2002 and 2003 Series rail-mounted terminal blocks

2002-482

**Item no.: 2009-412**

Push-in type wire jumper; insulated; wire length 60 mm; Conductor cross section 1.5 mm²; suitable for 2001, 2002, 2003 and 2022 Series rail-mounted terminal blocks

2009-412

**Item no.: 2009-414**

Push-in type wire jumper; insulated; wire length 110 mm; Conductor cross section 1.5 mm²; suitable for 2001, 2002, 2003 and 2022 Series rail-mounted terminal blocks

2009-414

**Item no.: 2009-414/000-005**

Push-in type wire jumper; insulated; wire length 110 mm; Conductor cross section 1.5 mm²; suitable for 2001, 2002, 2003 and 2022 Series rail-mounted terminal blocks

2009-414

/000-005

**Item no.: 2009-414/000-006**

Push-in type wire jumper; insulated; wire length 110 mm; Conductor cross section 1.5 mm²; suitable for 2001, 2002, 2003 and 2022 Series rail-mounted terminal blocks

2009-414

/000-006

**Item no.: 2009-416**

Push-in type wire jumper; insulated; wire length 250 mm; Conductor cross section 1.5 mm²; suitable for 2001, 2002, 2003 and 2022 Series rail-mounted terminal blocks

2009-416

**Item no.: 210-103**

Wire commoning chain; insulated; 50 connections

210-103

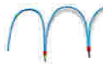
**Item no.: 210-123**

Wire commoning chain; insulated; 50 connections

210-123

General accessories**Item no.: 2022-161**

Start module for 1-conductor female connector; with integrated end plate; 2.5 mm²; 1-pole

2022-161

**Item no.: 2022-162**

Start module for 1-conductor female connector; with integrated end plate; 2.5 mm²; 1-pole

2022-162

**Item no.: 2022-164**

Start module for 1-conductor female connector; with integrated end plate; 2.5 mm²; 1-pole

2022-164

**Item no.: 2022-167**

















Start module for 1-conductor female connector; with integrated end plate; 2.5 mm²; 1-pole

















2022-167















**Item no.: 2022-171**











Center module for 1-conductor female connector; 2.5 mm²; 1-pole

2022-171

	Item no.: 2022-172 Center module for 1-conductor female connector; 2.5 mm ² ; 1-pole	2022-172
	Item no.: 2022-174 Center module for 1-conductor female connector; 2.5 mm ² ; 1-pole	2022-174
	Item no.: 2022-177 Center module for 1-conductor female connector; 2.5 mm ² ; 1-pole	2022-177
	Item no.: 2022-181 End module for 1-conductor female connector; 2.5 mm ² ; 1-pole	2022-181
	Item no.: 2022-182 End module for 1-conductor female connector; 2.5 mm ² ; 1-pole	2022-182
	Item no.: 2022-184 End module for 1-conductor female connector; 2.5 mm ² ; 1-pole	2022-184
	Item no.: 2022-187 End module for 1-conductor female connector; 2.5 mm ² ; 1-pole	2022-187
Marking accessories		
	Item no.: 2002-161 Adaptor	2002-161
	Item no.: 2009-110 Marking strips; on reel; not stretchable; plain; snap-on type	2009-110
	Item no.: 2009-115 WMB-Inline; for Smart Printer; on reel; stretchable 5 - 5.2 mm; plain; snap-on type	2009-115
	Item no.: 2009-115/000-002 WMB-Inline; for Smart Printer; on reel; stretchable 5 - 5.2 mm; plain; snap-on type	2009-115 /000-002
	Item no.: 2009-115/000-005 WMB-Inline; for Smart Printer; on reel; stretchable 5 - 5.2 mm; plain; snap-on type	2009-115 /000-005
	Item no.: 2009-115/000-006 WMB-Inline; for smartPRINTER; on reel; stretchable 5 - 5.2 mm; plain; snap-on type	2009-115 /000-006
	Item no.: 2009-115/000-007 WMB-Inline; for Smart Printer; on reel; stretchable 5 - 5.2 mm; plain; snap-on type	2009-115 /000-007
	Item no.: 2009-115/000-012 WMB-Inline; for smartPRINTER; on reel; stretchable 5 - 5.2 mm; plain; snap-on type	2009-115 /000-012
	Item no.: 2009-115/000-017 WMB-Inline; for Smart Printer; on reel; stretchable 5 - 5.2 mm; plain; snap-on type	2009-115 /000-017
	Item no.: 2009-115/000-023 WMB-Inline; for Smart Printer; on reel; stretchable 5 - 5.2 mm; plain; snap-on type	2009-115 /000-023

	Item no.: 2009-115/000-024 WMB-Inline; for smartPRINTER; on reel; stretchable 5 - 5.2 mm; plain; snap-on type	/000-024	2009-115
	Item no.: 2009-145 Mini-WSB Inline; for Smart Printer; on reel; stretchable 5 - 5.2 mm; plain; snap-on type		2009-145
	Item no.: 2009-145/000-002 Mini-WSB Inline; for Smart Printer; on reel; stretchable 5 - 5.2 mm; plain; snap-on type	/000-002	2009-145
	Item no.: 2009-145/000-005 Mini-WSB Inline; for Smart Printer; on reel; stretchable 5 - 5.2 mm; plain; snap-on type	/000-005	2009-145
	Item no.: 2009-145/000-006 Mini-WSB Inline; for Smart Printer; on reel; stretchable 5 - 5.2 mm; plain; snap-on type	/000-006	2009-145
	Item no.: 2009-145/000-007 Mini-WSB Inline; for Smart Printer; on reel; stretchable 5 - 5.2 mm; plain; snap-on type	/000-007	2009-145
	Item no.: 2009-145/000-012 Mini-WSB Inline; for Smart Printer; on reel; stretchable 5 - 5.2 mm; plain; snap-on type	/000-012	2009-145
	Item no.: 2009-145/000-023 Mini-WSB Inline; for smartPRINTER; on reel; stretchable 5 - 5.2 mm; plain; snap-on type	/000-023	2009-145
	Item no.: 2009-145/000-024 Mini-WSB Inline; for Smart Printer; on reel; stretchable 5 - 5.2 mm; plain; snap-on type	/000-024	2009-145
	Item no.: 2009-191 Group marker carrier		2009-191
	Item no.: 2009-192 Group marker carrier		2009-192
	Item no.: 2009-193 Group marker carrier		2009-193
	Item no.: 2009-198 Adaptor		2009-198
	Item no.: 248-501 Miniature WSB Quick marking system; plain; Marker width 5 mm; 10 strips with 10 markers per card		248-501
	Item no.: 248-501/000-002 Mini-WSB marking card; as card; not stretchable; plain; snap-on type	/000-002	248-501
	Item no.: 248-501/000-005 Mini-WSB marking card; as card; not stretchable; plain; snap-on type	/000-005	248-501

	Item no.: 248-501/000-006 Mini-WSB marking card; as card; not stretchable; plain; snap-on type	/000-006	248-501
	Item no.: 248-501/000-007 Mini-WSB marking card; as card; not stretchable; plain; snap-on type	/000-007	248-501
	Item no.: 248-501/000-012 Mini-WSB marking card; as card; not stretchable; plain; snap-on type	/000-012	248-501
	Item no.: 248-501/000-017 Mini-WSB marking card; as card; not stretchable; plain; snap-on type	/000-017	248-501
	Item no.: 248-501/000-023 Mini-WSB marking card; as card; not stretchable; plain; snap-on type	/000-023	248-501
	Item no.: 248-501/000-024 Mini-WSB marking card; as card; not stretchable; plain; snap-on type	/000-024	248-501
	Item no.: 793-501 WMB marking card; as card; not stretchable; plain; snap-on type		793-501
	Item no.: 793-501/000-002 WMB marking card; as card; not stretchable; plain; snap-on type	/000-002	793-501
	Item no.: 793-501/000-005 WMB marking card; as card; not stretchable; plain; snap-on type	/000-005	793-501
	Item no.: 793-501/000-006 WMB marking card; as card; not stretchable; plain; snap-on type	/000-006	793-501
	Item no.: 793-501/000-007 WMB marking card; as card; not stretchable; plain; snap-on type	/000-007	793-501
	Item no.: 793-501/000-012 WMB marking card; as card; not stretchable; plain; snap-on type	/000-012	793-501
	Item no.: 793-501/000-017 WMB marking card; as card; not stretchable; plain; snap-on type	/000-017	793-501
	Item no.: 793-501/000-023 WMB marking card; as card; not stretchable; plain; snap-on type	/000-023	793-501
	Item no.: 793-501/000-024 WMB marking card; as card; not stretchable; plain; snap-on type	/000-024	793-501

	<p>Item no.: 793-5501 WMB marking card; as card; for terminal block width 5 - 17.5 mm; stretchable 5 - 5.2 mm; plain; snap-on type</p>		793-5501
	<p>Item no.: 793-5501/000-002 WMB marking card; as card; for terminal block width 5 - 17.5 mm; stretchable 5 - 5.2 mm; plain; snap-on type</p>	/UUU-UU2	793-5501
	<p>Item no.: 793-5501/000-005 WMB marking card; as card; stretchable 5 - 5.2 mm; plain; snap-on type</p>	/UUU-UU5	793-5501
	<p>Item no.: 793-5501/000-006 WMB marking card; as card; stretchable 5 - 5.2 mm; plain; snap-on type</p>	/UUU-UU6	793-5501
	<p>Item no.: 793-5501/000-007 WMB marking card; as card; stretchable 5 - 5.2 mm; plain; snap-on type</p>	/UUU-UU7	793-5501
	<p>Item no.: 793-5501/000-012 WMB marking card; as card; stretchable 5 - 5.2 mm; plain; snap-on type</p>	/UUU-U12	793-5501
	<p>Item no.: 793-5501/000-014 WMB marking card; as card; stretchable 5 - 5.2 mm; plain; snap-on type</p>	/UUU-U14	793-5501
	<p>Item no.: 793-5501/000-017 WMB marking card; as card; stretchable 5 - 5.2 mm; plain; snap-on type</p>	/UUU-U17	793-5501
	<p>Item no.: 793-5501/000-023 WMB marking card; as card; stretchable 5 - 5.2 mm; plain; snap-on type</p>	/UUU-U23	793-5501
	<p>Item no.: 793-5501/000-024 WMB marking card; as card; stretchable 5 - 5.2 mm; plain; snap-on type</p>	/UUU-U24	793-5501

Downloads
Documentation

Bid Text

2022-1201	docx 15.5 kB	Download
-----------	-----------------	----------

Additional Information

	pdf 2.1 MB	Download
--	---------------	----------

CAD/CAE - Smart Data

CAD data



3D Download 2022-1201

URL

Download

Product family

X-COM S

Show all products from the family

Subject to changes.
